

KA 34/600



The KA 34 SHEV chain drive with 300 N of force is suitable for mounted installation. Can be used nearly anywhere thanks to a variety of bracket solutions.

Performance features

- + Can be used for openings for smoke exhaust; D+H Euro SHEV in accordance with EN 12101-2; and for daily ventilation
- + With motor electronics controlled via microprocessor
- + High-speed function (HS) for especially fast opening windows in case of fire (SHEV)
- + Special chain stabilisation
- + Pressure applications up to 700 mm, application tension stroke lengths >1000 mm possible
- + Relief of pressure on window gasket after closing process
- + Programmable drive functions and different drive parameters
- + Running speed in CLOSED direction decreases to 5 mm/s (passive closing edge protection)
- + Time-controlled reversing when an obstacle is detected in the CLOSED direction (active closing edge protection)

Approvals / Certificates

Find out about permission details from your D+H Partner.



G 503007



5014068.18005-1



Article also available with the following permissions under other article numbers. Technical data may deviate.



CNBOP-PIB



Technical data

KA 34/600

Supply	24 V DC / $\pm 15\%$ / 1 A
Duty cycle	30 % (ON: 3 min. / OFF: 7 min.)
Force of pressure	300 N
Tensile force	300 N
Nominal locking force **	Max. 2600 N (2000 N ***)
Service life	20000 double strokes *
Stroke	600 mm
OPEN running speed	11.8 mm/s
OPEN running speed - SHEV	12.2 mm/s
CLOSED running speed	11.8 mm/s
Type of protection	IP 32
Emission sound pressure level	LpA ≤ 70 dB(A)
Temperature range	-15 °C (-5 °C ***) ... +75 °C
Fire resistance	B300 (30 min / 300 °C)
Housing	Aluminium
Surface	Powder-coated
Colour	White aluminium (~ RAL 9006)
Connection	2.5 m silicone cable
Dimension A	546 mm
Dimension B	372.5 mm
W x H x D	546 x 40 x 59 mm
Weight	2.2 kg
Art. No.	26.000.20

* For vertical use, please consult with D+H Sales!

** Depending on the mounting, *** in accordance with VdS 2580

Dimensions

All specifications in mm

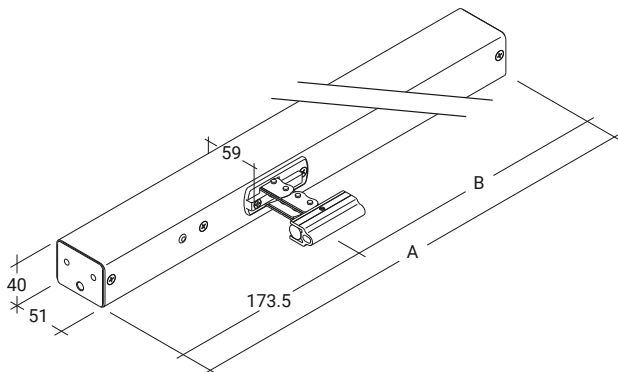

Pressure load diagram

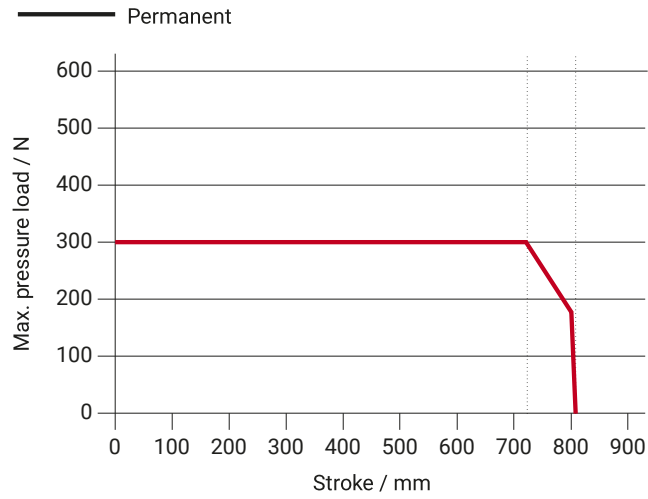

Possible applications

- + Mounted installation
- + Frame mounting
- + Sash mounting
- + Application force
- + Application tension

